

ALUMINIUM WINDOWS AND DOORS



A view to the future

HANLON WINDOWS AUSTRALIA PTY LIMITED



CONTENTS

Window styles	1
Window codes	1
502 Aluminium sliding windows	2
549/548 Hinged doors	2
516/517 Aluminium casement	3
514 Aluminium double hung	3
516/517 Aluminium awning windows	4
541 Aluminium sliding doors	4
542 Aluminium stacking doors	5
618 Aluminium stacking doors	5
548 Aluminium bi-fold doors	6
525 Aluminium louvres	7
S1 Retractable screens	7
On site care	8
Window building – in detail	8
Building in diagrams	Inside back cover



All standard Hanlon timber and aluminium frames have been designed and glazed in accordance with the relevant Australian Standards. For non-standard designs and configurations we recommend you consult your nearest Hanlon Windows Australia Representative.

Our Aluminium window range offers an easy care modern alternative to PVC windows. The top of the range products include the latest innovative designs available in a wide range of colours to suit modern architectural requirements.

All window details and codes used in this size and range brochure are for Hanlon standard sizes. Custom built windows can be made to your specifications as a variation to our standard designs.

Most of the Aluminium range is classed as thermally improved and we also have a series of Thermally Broken windows & doors. This meets the BASIX requirements to help greenhouse emissions.

Hanlon Windows assume no responsibility for errors, omissions or any consequences of reliance solely on this publication.

For further information:

www.hanlonwindows.com.au

sales@hanlonwindows.com.au

WINDOW STYLES

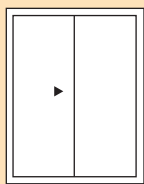

SLIDER

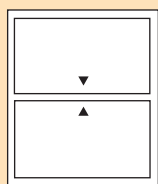

DOUBLE HUNG

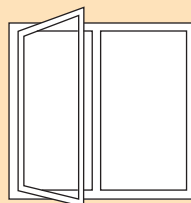

CASEMENT

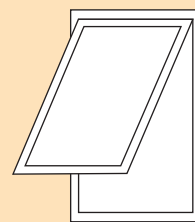

AWNING WINDOW

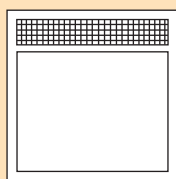

MESH VENT

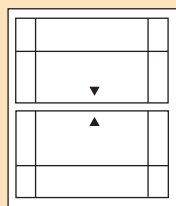

FEDERATION BAR

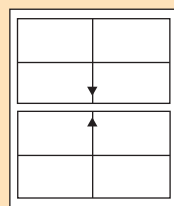

COLONIAL BAR

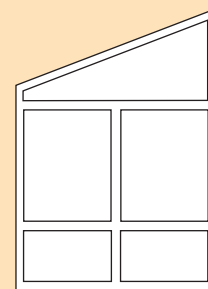

RAKED HEAD WINDOW

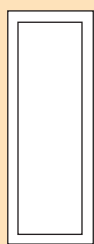

FIXED LIGHT

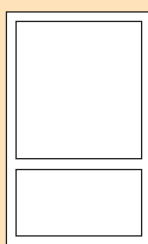

TRANSOM WINDOW

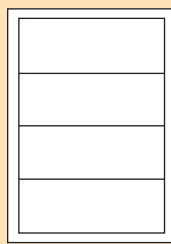

LOUVRE

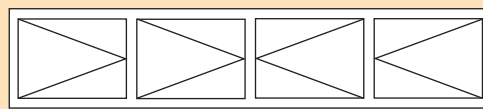

BI-FOLD WINDOWS



CIRCULAR SPECIALTY WINDOW

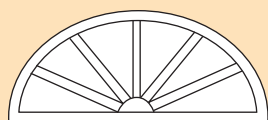

SUNBURST

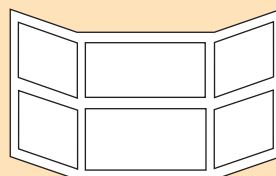

135° BAY WINDOW

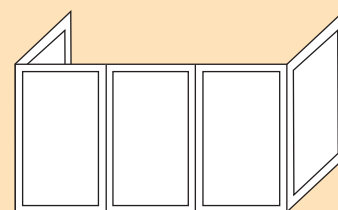

90° BAY WINDOW

WINDOW CODES

ALL WINDOWS ARE VIEWED FROM OUTSIDE

EXAMPLE:

The letters at the start of the code indicate the window type (eg. **SF** 1012 - slider fixed).

The first two numbers indicate the approximate height (eg. **SF 1012** - 1029mm high).

The last two numbers indicate the approximate width (eg. **SF 1012** - 1210mm wide).

If there is a letter at the end of the code it indicates the transom or chair rail type (eg. **SF 2112 T**).

D – Double Hung

A – Awning

C – Casement

XF – Sliding door

AL – Louvre

DF – Double Hung/Fixed

AF – Awning/Fixed

CF – Casement Fixed

BF – Bi-fold door



























































































CR – Chair rail

T – Transom

SD – Stacking Sliding Doors

XC – Slider/Clearvent

502 ALUMINIUM SLIDING WINDOWS

Stud Opening	665	905	1265	1625	1865	2105	2465	2705	2945	
Frame Size	610	850	1210	1570	1810	2050	2410	2650	2890	
655	600	 SF0606	 SF0608	 SF0612	 SF0615	 SF0618	 SFS0621	 SFS0624	 SFS0627	 SFS0630
910	857	 SF0806	 SF0808	 SF0812	 SF0815	 SF0818	 SFS0821	 SFS0824	 SFS0827	 SFS0830
990	935	 SF0906	 SF0908	 SF0912	 SF0915	 SF0918	 SFS0921	 SFS0924	 SFS0927	 SFS0930
1085	1029	 SF1006	 SF1008	 SF1012	 SF1015	 SF1018	 SFS1021	 SFS1024	 SFS1027	 SFS1030
1255	1200	 F1206 *	 SF1208	 SF1212	 SF1215	 SF1218	 SFS1221	 SFS1224	 SFS1227	 SFS1230
1420	1365	 F1306 *	 SF1308	 SF1312	 SF1315	 SF1318	 SFS1321	 SFS1324	 SFS1327	 SFS1330
1510	1457	 F1506 *	 SF1508	 SF1512	 SF1515	 SF1518	 SFS1521	 SFS1524	 SFS1527	 SFS1530
1855	1800	 F1806T *	 SF1808T	 SF1812T	 SF1815T	 SF1818T	 SFS1821T	 SFS1824T	 SFS1827T	 SFS1830T
1985	1930	 F1906T *	 SF1908T	 SF1912T	 SF1915T	 SF1918T	 SFS1921T	 SFS1924T	 SFS1927T	 SFS1930T
2110	2057	 F2106T *	 SF2108T	 SF2112T	 SF2115T	 SF2118T	 SFS2121T	 SFS2124T	 SFS2127T	 SFS2130T

STANDARD SIZES

* Denotes window too narrow for sliding sash ■ Vent locks available (centre shaft)

549/548 HINGED DOORS

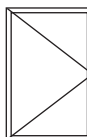
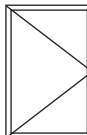
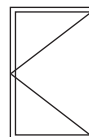
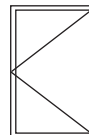
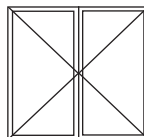
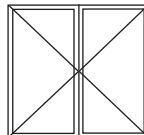
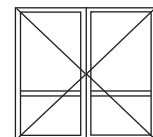
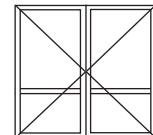
Stud Opening	955	955	1855	1855
Frame Size	900	900	1800	1800
2145 (2445)	 LEH2109  LIH2109	 REH2109  RIH2109	 EHH2118  IHH2118	 EHH2118CR  IHH2118CR

■ LEH - Left Hand Hinge - External Swing (open out)

■ REH - Right Hand Hinge - External Swing (open out)

■ EHH - External Swing (open out)

■ 549 has double rebate can accommodate Flydoor

■ LIH - Left Hand Hinge - Internal Swing (open in)

■ RIH - Right Hand Hinge - Internal Swing (open in)















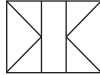
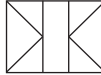



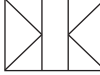
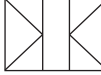







■ IHH - Internal Swing (open in)

■ 2400 high doors available on request







































































■ Parliament Hinges available

■ 'H' pattern motif (perforated)

516/517 ALUMINIUM CASEMENT

















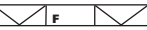















































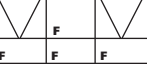

Stud Opening		665	1265	1625	1865	2105	2465	2705		
Frame Size		610	1210	1570	1810	2050	2410	2650		
655	600	 C0606	 CF0612	 CF0615	 CF0618	 CFC0621	 CFC0624	 FCF0627		
990	935	 C0906	 CF0912	 CF0915	600 Wide Sashes		 CFC0921	 CFC0924	 CFC0927	
1085	1029	 C1006	 CF1012	 CF1015	600 Wide Sashes		 CFC1021	 CFC1024	600 Wide Sashes	
1255	1200	 C1206	 CF1212	600 Wide Sashes		 CFC1221	600 Wide Sashes			
1420	1365	 C1306	 CF1312							
1855	1800	 C1806T	 CF1812T							<p>NOTE: Due to Australian Wind Load requirements Sash width is restricted to 600mm</p> <p>OPTIONAL VARIATIONS</p> <ul style="list-style-type: none"> ■ CF are also available as CC's ■ CFC are also available as FCF, CCC ■ Hand of Sash can be reversed ■ Fly Screens not available to series 516
1995	1930	 C1906T	 CF1912T							
2110	2057	 C2106T	 CF2112T							

514 ALUMINIUM DOUBLE HUNG

Stud Opening		665	905	1265	1265	1625	1625	1865	1865	2465	2705
Frame Size		610	850	1210	1210	1570	1570	1810	1810	2410	2650
990	935	 D0906	 D0908	 DD0912	 DF0912	 DD0915	 DF0915	 DD0918	 DF0918	 DFD0924	 DFD0927
1085	1029	 D1006	 D1008	 DD1012	 DF1012	 DD1015	 DF1015	 DD1018	 DF1018	 DFD1024	 DFD1027
1255	1200	 D1206	 D1208	 DD1212	 DF1212	 DD1215	 DF1215	 DD1218	 DF1218	 DFD1224	 DFD1227
1420	1365	 D1306	 D1308	 DD1312	 DF1312	 DD1315	 DF1315	 DD1318	 DF1318	 DFD1324	 DFD1327
1510	1457	 D1506	 D1508	 DD1512	 DF1512	 DD1515	 DF1515	 DD1518	 DF1518	 DFD1524	 DFD1527
1855	1800	 D1806	 D1808	 DD1812	 DF1812	 DD1815	 DF1815	 DD1818	 DF1818	 DFD1824	 DFD1827
2110	2057	 D2106	 D2108	 DD2112	 DF2112	 DD2115	 DF2115	 DD2118	 DF2118	 DFD2124	 DFD2127

■ Transom Type ■ Federation Bars ■ Colonial Bars ■ Motif on fixed panel of 1800/2057 high windows

516/517 ALUMINIUM AWNING WINDOWS

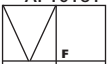
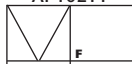
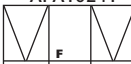
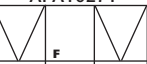
Stud Opening	665	905	1265	1625	1865	2105	2465	2705
Frame Size	610	850	1210	1570	1810	2050	2410	2650
655 600	 A0606	 A0608	 AF0612	 AF0615	 AF0618	 AF0621	 AFA0624	 AFA0627
990 935	 A0906	 A0908	 AF0912	 AF0915	 AF0918	 AF0921	 AFA0924	 AFA0927
1085 1029	 A1006	 A1008	 AF1012	 AF1015	 AF1018	 AF1021	 AFA1024	 AFA1027
1255 1200	 A1206	 A1208	 AF1212	 AF1215	 AF1218	 AF1221	 AFA1224	 AFA1227
1420 1365	 A1306	 A1308	 AF1312	 AF1315	 AF1318	 AF1321	 AFA1324	 AFA1327
1510 1457	 A1506	 A1508	 AF1512	 AF1515	 AF1518	 AF1521	 AFA1524	 AFA1527
1855 1800	 A1806T	 A1808T	 AF1812T	 AF1815T	 AF1818T	 AF1821T	 AFA1824T	 AFA1827T
1985 1930	 A1906T	 A1908T	 AF1912T	 AF1915T	 AF1918T	 AF1921T	 AFA1924T	 AFA1927T
2110 2057	 A2106T	 A2108T	 AF2112T	 AF2115T	 AF2118T	 AF2121T	 AFA2124T	 AFA2127T

NOTE: keyed chainwinder supplied in black as standard stainless steel chain
 ■ Minimum width & height 450mm

541 ALUMINIUM SLIDING DOORS

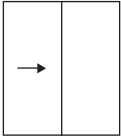
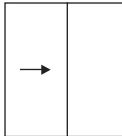
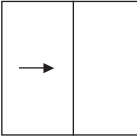
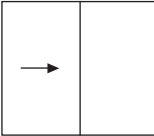
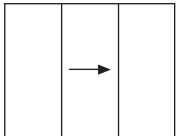
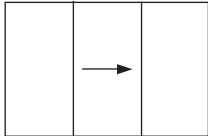
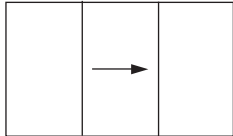
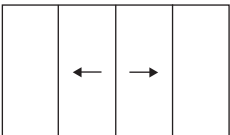
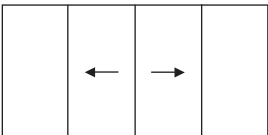
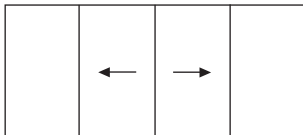
Stud Opening	1575	1870	2175	2470
Frame Size	1520	1814	2120	2414
2145 (2445)	 XF2115	 XF2118	 XF2121	 XF2124
Stud Opening	2780	3240	3680	
Frame Size	2726	3185	3626	
2145 (2445)	 FXF2127	 FXF2131	 FXF2136	
Stud Opening	3640	4255	4840	
Frame Size	3587	4199	4787	
2145 (2445)	 FXXF2135	 FXXF2142	 FXXF2148	

542 ALUMINIUM STACKING DOORS

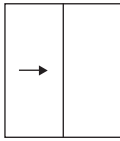
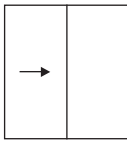
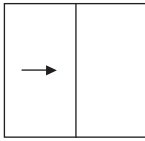
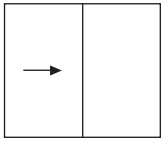
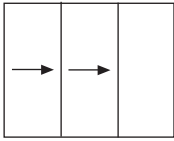
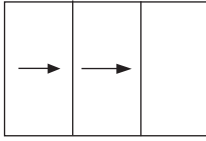
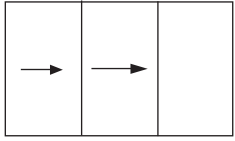
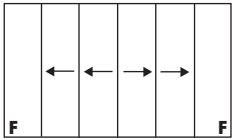
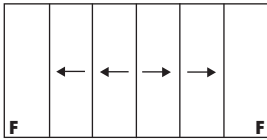
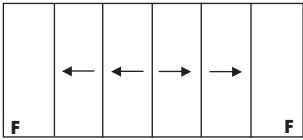
Stud Opening		1870	2185	2470	2780
Frame Size		1814	2120	2414	2726
2145 (2445)	2104 (2400)				
		SD2118XF	SD2121XF	SD2124XF	SD2127XF
Stud Opening		2780	3240	3680	
Frame Size		2726	3185	3626	
2145 (2445)	2104 (2400)				
		SD2127XXF	SD2131XXF	SD2136XXF	
Stud Opening		3640	4255	4840	
Frame Size		3587	4199	4787	
2145 (2445)	2104 (2400)				
		SD2135FXXXXF	SD2142FXXXXF	SD2148FXXXXF	

618 ALUMINIUM STACKING DOORS

XC = CLEAR VENT WINDOW IN FIXED DOOR PANEL

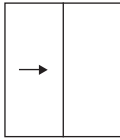
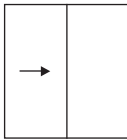
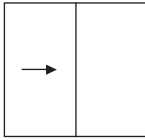
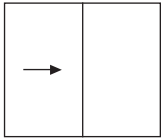
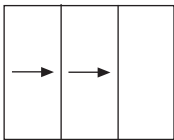
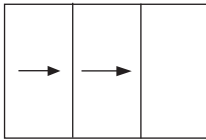
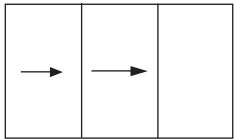
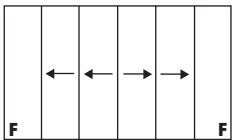
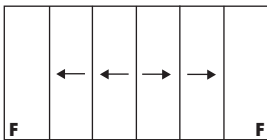
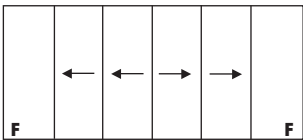
Stud Opening		1870	2185	2470	2780
Frame Size		1814	2120	2414	2726
2145 (2745)	2104 (2700)				
		SD2118XF	SD2121XF	SD2124XF	SD2127XF
Stud Opening		2780	3240	3680	
Frame Size		2726	3185	3626	
2145 (2745)	2104 (2700)				
		SD2127XXF	SD2131XXF	SD2136XXF	
Stud Opening		3640	4255	4840	
Frame Size		3587	4199	4787	
2145 (2745)	2104 (2700)				
		SD2135FXXXXF	SD2142FXXXXF	SD2148FXXXXF	

STANDARD ON DOORS





- Keyed Dead Locks
- Toughened Glass
- Motif

OPTIONAL VARIATIONS

- Up to 12000 wide
- 2700 high
- Low E Glass & Double Glazing
- Opposite Hands available on request

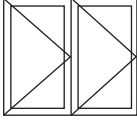
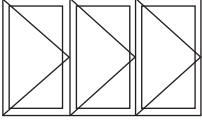
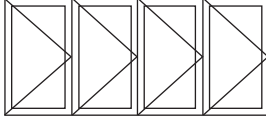
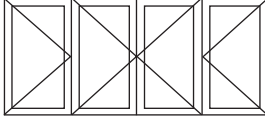
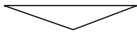
NOTE 541: Maximum panel width available - 1200
 542: Maximum panel width available - 1350
 618: Maximum panel width available - 1500
 Larger doors available in commercial range



548 ALUMINIUM BI-FOLD DOORS

Stud Opening		1575	2470	3240	3240
Door Size		1520	2414	3185	3185
2145 (2445)	2104 (2400)				
		BF2115-2L	BF2124-3L	BF2131-4L	BF2131-2L/2R
					



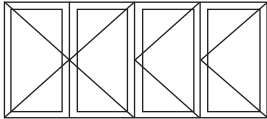
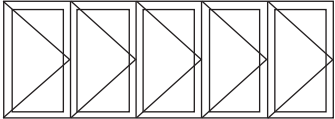
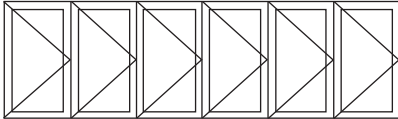

This configuration cannot be opened from the outside as there is no swinging leaf

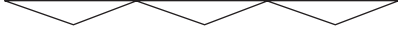
This configuration cannot be opened from the outside as there is no swinging leaf

This configuration cannot be opened from the outside as there is no swinging leaf

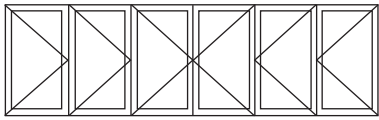
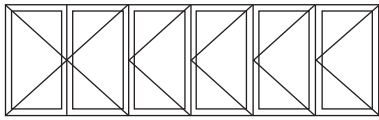
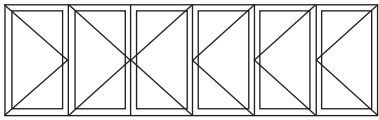
Stud Opening		3240	3680	4840
Door Size		3185	3626	4787
2145 (2445)	2104 (2400)			
		BF2131-1L/3R	BF2136-5L	BF2148-6L
				

This configuration cannot be opened from the outside as there is no swinging door

Stud Opening		4840	4840	4840
Door Size		4787	4787	4787
2145 (2445)	2104 (2400)			
		BF2148-3L/3R	BF2148-1L/5R	BF2148-2L/4R
				

This configuration cannot be opened from the outside as there is no swinging door

NOTE:

Hardware and door furniture is standard in black and white. Special colours available on request.

- Maximum door panel width is 900mm
- Configurations over 60kgs are site glazed
- Opposite hand and special size assemblies available on request

- Recessed sill available
- Motif standard
- Wider doors available in 410 series
- Maximum overall width 5350mm
- S1 Retractable Screens available

Stud Opening	665		905	No. of Blades
	Frame Size	610	850	
409	354			2
		AL0306	AL0308	
549	494			3
		AL0406	AL0408	
689	634			4
		AL0606	AL0608	
829	774			5
		AL0706	AL0708	
969	914			6
		AL0806	AL0808	
1109	1054			7
		AL1006	AL1008	
1249	1194			8
		AL1106	AL1108	

Stud Opening	665		905	No. of Blades
	Frame Size	610	850	
1389	1334			9
		AL1306	AL1308	
1529	1474			10
		AL1406	AL1408	
1669	1614			11
		AL1506	AL1508	
1809	1754			12
		AL1706	AL1708	
1949	1894			13
		AL1806	AL1808	
2089	2034			14
		AL2006	AL2008	
2229	2174			15
		AL2106	AL2108	

NOTE:

Heights of Louvres windows are set to accommodate full size blades 152mm. Sizes do not always match Hanlon standard heights. Matching heights including fixed blade available on request.

■ 102mm available on request at a different size ■ Laminated blades not available ■ Keylocks optional

IMPORTANT: Be sure to nominate colour of louvre mechanics at time of order.

S1 RETRACTABLE SCREENS

S1E Eco-Screen - Max frame size

Single System	
Insectscreen	3.2m (H) x 3.9m (W)
Blind	2.45m (H) x 3.9m (W)
Double System	
Insectscreen	3.2m (H) x 7.6m (W)
Blind	2.45m (H) x 7.6m (W)
Multi-function System	2.45m (H) x 3.9m (W)

The S1E Eco-Screen™ from Centor Architectural is a revolutionary product providing eco-friendly retractable insect screening and solar control with fingertip operation. This product is the evolution of Centor's award-winning S1 Insect Screen.

S1E allows homeowners to have complete control of their living environment. Used singly or paired together S1E is ready for use whatever the season or time of day. S1E retracts horizontally and discreetly into its frame when not in use – a revolutionary solution for those who refuse to compromise on style.

On openings up to 3.9m wide either single or multi-function options are available.

Where a single function is required choose from insect screen or sun filter fabric. For a multi-function option select both fabrics to create a two-in-one screening solution.

Create a multi-function system using sun filter and insect fabrics to provide solar control in the mornings and prevent insects entering the home in the evenings.

Single Function System

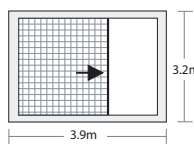

Option 1 - Screen from right or left

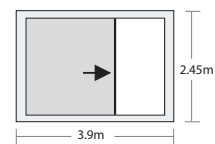

Option 2 - Blind from right or left

Double System

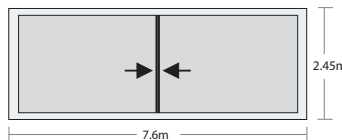

Option 1 - Blind from right or left

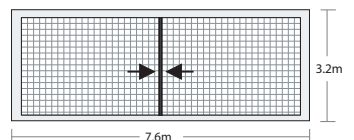

Option 2 - Screen from right or left

Multi-function System

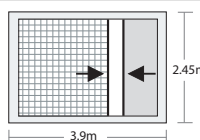

Option 1 - screen from left, blind from right

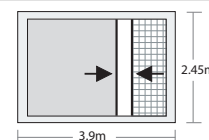

Option 2 - screen from right, blind from left

RECOMMENDED STORAGE AND CLEANING INFORMATION

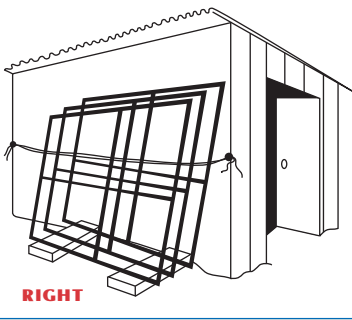

If windows and/or doors are to be stored on site they should be in a secure clean dry area away from cement, lime, paint, acid etc. as these items may damage the finish. During installation they must be protected from building fall-out such as wet plaster, mortar, paint and welding splatter. Wet plaster and mortar should be removed immediately and soiled area washed down with ample quantities of clean water.

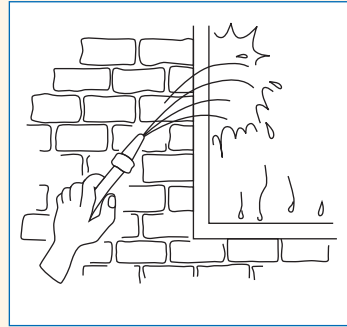

Acid used for cleaning brickwork must be prevented from getting onto aluminium. Should this occur the acid must immediately be washed off with clean water.

This is the most common cause of permanent damage to the finish.

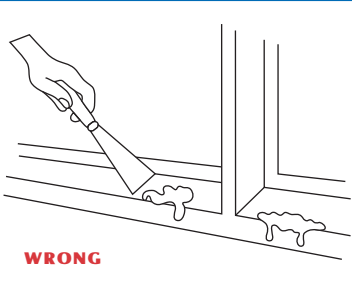

If you have to scrape off dry cement or mortar droppings the surface will almost certainly be damaged.

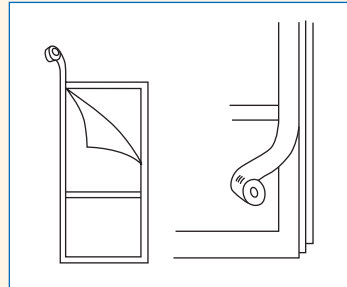

Tapes or coatings used to protect exposed surfaces must be removed carefully. Lengthy exposure to sunlight can make them difficult to remove.

Door tracks and window sills should be protected from planks, scaffolding and barrows.

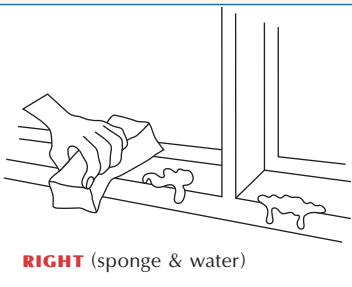

Use a sponge and lots of clean water to remove cement and mortar before it sets and causes permanent damage to paint or anodised finishes.

WINDOW BUILDING – IN DETAIL

RECOMMENDED INSTALLATION INSTRUCTIONS FOR ALUMINIUM WINDOWS

Fix the window to structure with steel building-in lugs or nails, shim as indicated.

Installation of windows to be in accordance with Australian Standard AS 2048.

Suggested installation steps:

1. If flashing is required fit the flashing to sill.
2. Fit shims on sill plate/slab on meeting stile or mullion centre line and at 450mm maximum centres. Make sure these shims are level.
3. Install the frame into the opening.
4. Fit shims on jambs making sure that frame is plumb and square, measure frame across diagonals to check for square.
5. Fix the frame to structure by nailing through timber reveals. Make sure that frame is not twisted. Alternative – On solid brick construction fit galvanised M.S. building-in lugs at 450mm maximum centres.
6. Take care that head, sill and/or jamb are not dished or bowed during construction.
7. Make sure the sill reveal is fully supported, if necessary use additional shims. Failure to do so may result in defective sash operation.
8. Cement mortar droppings can permanently damage aluminium. Remove cement as soon as possible.
9. Leave at least 10mm gap between sill brick and frame to allow for possible future building settlement.
10. On brick veneer construction there should be at least a 12mm gap between timber header and aluminium frame.
11. Aluminium windows are not designed to support eaves linings.

DOUBLE-HUNG WINDOW

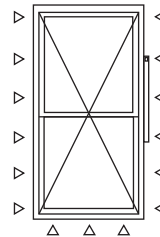

Check measure diagonals during installation.

Building-in lugs at approx. 450mm maximum centres.

On double-hung windows ensure jambs are plumb and straight.

TRANSOM WINDOWS

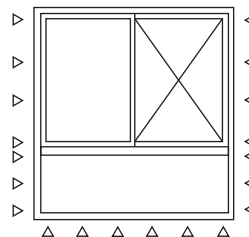

Double fix at transoms.

Important Note:

If you install windows out of square or without sufficient shims the opening sashes won't perform satisfactorily.

50MM WINDOWS JAMB

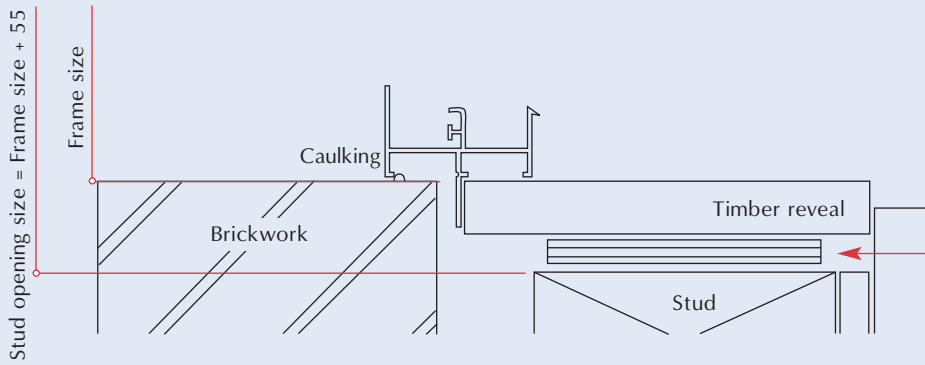

Fixings at 450mm maximum centres. These centres would be reduced in high wind load areas.

Packing by builder

50MM WINDOWS HEAD

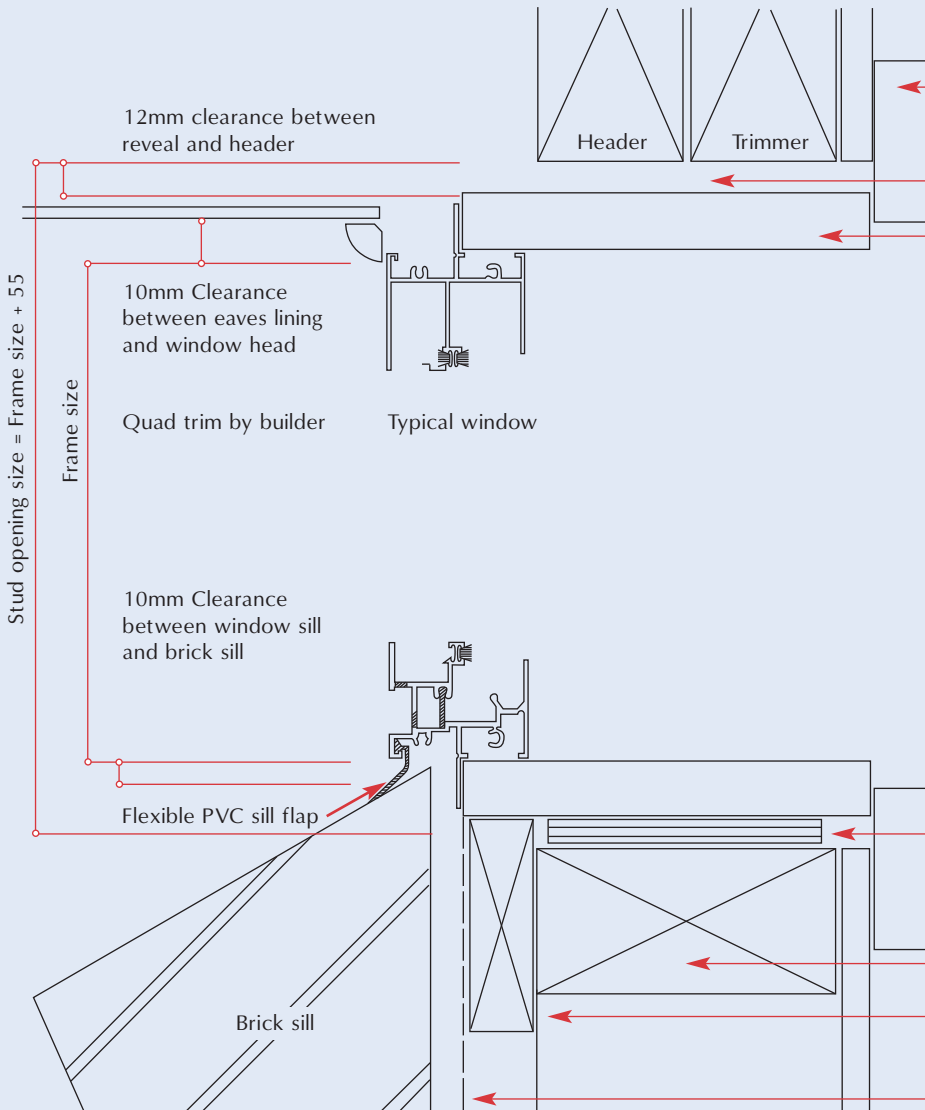

Fixings at 450mm maximum centres. These centres would be reduced in high wind load areas.

50MM WINDOWS SILL

Packing by builder

Sill plate

Sill support by builder

Flashing

NOTES:

Windows are non-structural and can't support the weight of the structure.

Fit bond-breaker between cement and aluminium window frame to prevent caustic attack on the metal finish. If any wet cement should fall onto the metal or glass, remove straight away with water and soft sponge.

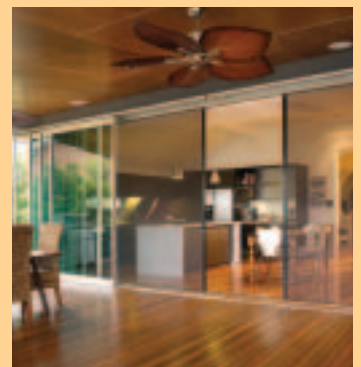

Servicing Sydney, Wollongong,
Southern Highlands, Shoalhaven,
ACT & Far South Coast Areas.



HANLON WINDOWS AUSTRALIA PTY LIMITED

Showroom Locations:

Head Office
41 Bolong Road
Bomaderry NSW 2541
Tel: (02) 4421 5811
Fax: (02) 4421 0739

Unit C, 91-95
Victoria Road
Drummoyne NSW 2047
Tel: (02) 8752 8600
Fax: (02) 8752 8601

104 Industrial Road
Oak Flats NSW 2529
Tel: (02) 4257 1012
Fax: (02) 4257 1238

HIA Home Ideas Centre
28 Collie Street
Fyshwick ACT 2609
Tel: (02) 6239 2233
Fax: (02) 6280 7611

Website: www.hanlonwindows.com.au • Email: sales@hanlonwindows.com.au



A view to the future