

TIMBER

WINDOWS AND DOORS



A view to the future

HANLON WINDOWS AUSTRALIA PTY LIMITED



CONTENTS

Window styles	1
Window codes	1
300 series cedar awning windows	2
Cedar sliding terrace doors	2
Cedar double hungs	3
Cedar sliding terrace doors slide-aside	3
Cedar double hung windows - standard colonial bar	4
300 series cedar casement windows	4
Cedar sliding windows	5
Cedar front entries & sidelights	5
Laundry frames	5
Cedar louvres	6
Retractable screening for eurodoor bi-folding	6
Cedar eurodoor bi-folding	7
Cedar hinged french doors	8
Building in diagrams	Inside back cover
Cedar bay window	Inside back cover



All standard Hanlon timber and aluminium frames have been designed and glazed in accordance with the relevant Australian Standards. For non-standard designs and configurations we recommend you consult your nearest Hanlon Windows Australia Representative.

Cedar is a species noted for its beautiful variation of colours and therefore no attempt is made to colour match timber components. Cedar is one of the finest joinery timbers in the world ideally suited for staining to enhance the rich variation in colours.

All window details and codes used in this size and range brochure are for Hanlon standard sizes. Custom built windows can be made to your specifications as a variation to our standard designs.

Note: Hanlon Windows Australia continually improves its product range using the latest technology and innovations in engineered components including laminating and veneering.

Hanlon Windows assume no responsibility for errors, omissions or any consequences of reliance solely on this publication.

For further information:

www.hanlonwindows.com.au

sales@hanlonwindows.com.au

WINDOW STYLES

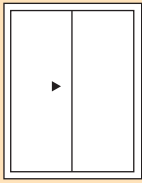

SLIDER

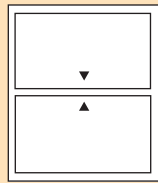

DOUBLE HUNG

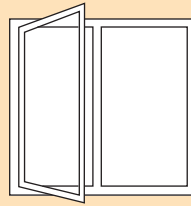

CASEMENT

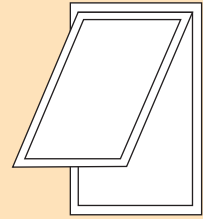

AWNING WINDOW

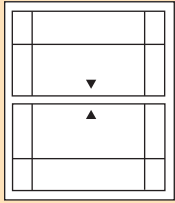

FEDERATION BAR

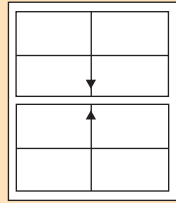

COLONIAL BAR

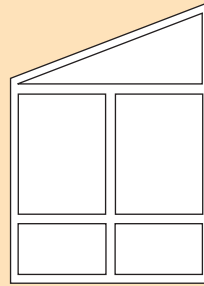

RAKED HEAD WINDOW

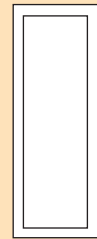

FIXED LIGHT

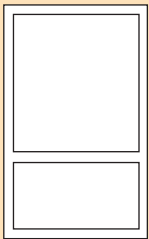

TRANSOM WINDOW



CHAIR RAIL DOOR



LOUVRES

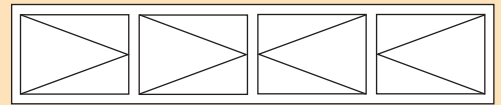

EURO BI-FOLD WINDOW

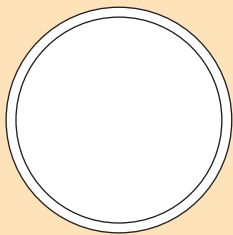

CIRCULAR SPECIALTY WINDOW

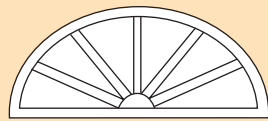

SUNBURST

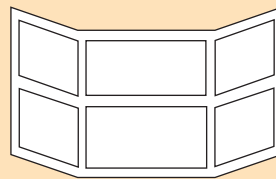

135° BAY WINDOW

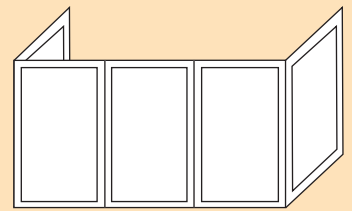

90° BAY WINDOW

WINDOW CODES

ALL WINDOWS ARE VIEWED FROM OUTSIDE

EXAMPLE:

The letters at the start of the code indicate the window type (eg. **TA** 1218 - **TA** Timber Awning).

The first two numbers indicate the approximate height (eg. **TA 1218** - 1198mm high).

The last two numbers indicate the approximate width (eg. **TA 1218** - 1810mm wide).

































































If there is a letter at the end of the code it indicates the transom or chair rail type (eg. **TA 2118 T**).

TA – Timber Awning
TH – Timber Double Hung
TF – Timber Fixed
TC – Timber Casement

TD – Terrace Sliding Door
TS – Timber Sliding Window
GD – Glass Door hinged
EU – Eurodoor Bi-folding

EUW – Euro Window
TL – Timber Louvre
TSA – Timber Slide-Aside

300 SERIES CEDAR AWNING WINDOWS

Stud Opening	630	870	1230	1590	1830	2070	2420	2790
Frame Size	608	848	1208	1568	1808	2048	2378	2768
620 598	 TA0606	 TA0608	 TA0612	 TA0615AF	 TA0618AF	 TA0621AF	 TA0624AFA	 TA0627AFA
958 938	 TA0906	 TA0908	 TA0912	 TA0915AF	 TA0918AF	 TA0921AF	 TA0924AFA	 TA0927AFA
1049 1028	 TA1006	 TA1008	 TA1012	 TA1015AF	 TA1018AF	 TA1021AF	 TA1024AFA	 TA1027AFA
1220 1198	 TA1206	 TA1208	 TA1212	 TA1215AF	 TA1218AF	 TA1221AF	 TA1224AFA	 TA1227AFA
1390 1368	 TA1306	 TA1308	 TA1312	 TA1315AF	 TA1318AF	 TA1321AF	 TA1324AFA	 TA1327AFA
1580 1538	 TA1506	 TA1508	 TA1512	 TA1515AF	 TA1518AF	 TA1521AF	 TA1524AFA	 TA1527AFA
1820 1798 ¹¹⁹⁸	 TA1806	 TA1808	 TA1812	 TA1815AF	 TA1818AF	 TA1821AF	 TA1824AFA	 TA1827AFA
2128 2108 ¹³⁶⁸	 TA2106	 TA2108	 TA2112	 TA2115AF	 TA2118AF	 TA2121AF	 TA2124AFA	 TA2127AFA

NOTE:

All sashes fitted with Keylock chainwinders or Truth winders.

- Width on Truth Hardware is 608mm
- Keylocks are not available with Truth Hardware
- Minimum width on chain winders is 450mm

HINGE



WINDER

CEDAR SLIDING TERRACE DOORS

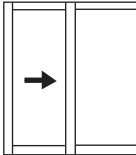
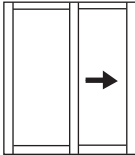
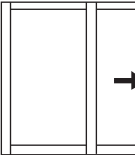
Stud Opening	1840	2140	2430	2785	3570	3570
Frame Size	1818	2118	2408	2765	3550	3560
2128 (2428) 2108 (2408)	 TD2118XF	 TD2121XF	 TD2124XF	 TD2127FXF	 TD2136 D1FXF	 TD2136 D2FXXF

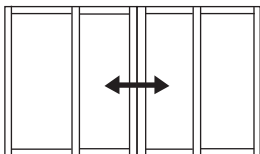
Stud Opening	4630
Frame Size	4608
2128 (2428) 2108 (2408)	 TD2146 D2FXXF

NOTE:

All doors supplied standard with Keyed deadlock. Hardware standard as beige, black or white. Special colours available on request.

- MOTIF to glass standard
- 2408 high option available
- Standard flyscreen door only
- Frames over 3600 wide may be joined

CEDAR DOUBLE HUNG

Stud Opening		630	870	1230	1590	1830	2070	2400	2790
Frame Size		610	850	1190	1570	1810	2050	2379	2769
958	938								
		TH0906D	TH0908D	TH0912DF	TH0915DF	TH0918DF	TH0921DF	TH0924DFD	TH0927DFD
1048	1028								
		TH1006D	TH1008D	TH1012DF	TH1015DF	TH1018DF	TH1021DF	TH1024DFD	TH1027DFD
1220	1198								
		TH1206D	TH1208D	TH1212DF	TH1215DF	TH1218DF	TH1221DF	TH1224DFD	TH1227DFD
1388	1368								
		TH1306D	TH1308D	TH1312DF	TH1315DF	TH1318DF	TH1321DF	TH1324DFD	TH1327DFD
1560	1538								
		TH1506D	TH1508D	TH1512DF	TH1515DF	TH1518DF	TH1521DF	TH1524DFD	TH1527DFD
1820	1798								
		TH1806D	TH1808D	TH1812DF	TH1815DF	TH1818DF	TH1821DF	TH1824DFD	TH1827DFD
2128	2108								
		TH2106D	TH2108D	TH2112DF	TH2115DF	TH2118DF	TH2121DF	TH2124DFD	TH2127DFD

NOTE:
Double hung windows fitted with spring balances. Keylocks in beige, black or white.

EXTRA OPENING SASHES AVAILABLE ON REQUEST

CEDAR COLONIAL BARS OPTIONAL See page 4.

CEDAR SLIDING TERRACE DOORS SLIDE-ASIDE

Stud Opening		2325	2670	3556
Frame Size		2305	2650	3536
2128	2108 (2428) (2408)			
		TSA 2123 XXF	TSA 2126 XXF	TSA 2135 XXF

Stud Opening		4556	5246	6146
Frame Size		4536	5226	6126
2128	2108			
		TSA 2145 FXXXXF	TSA 2152 FXXXXF	TSA 2161 FXXXXF

■ Flydoors not available ■ MOTIF to glass as standard
■ Frames over 3600 wide may be joined

CEDAR DOUBLE HUNG WINDOWS - STANDARD COLONIAL BAR

Stud Opening	630	870	1230	1590	1830	2070	2400	2790
Frame Size	610	850	1190	1570	1810	2050	2379	2769
958	938							
		TH0906D CB	TH0908D CB	TH0912DF CB	TH0915DF CB	TH0918DF CB	TH0921DF CB	TH0924DFD CB
1048	1028							
		TH1006D CB	TH1008D CB	TH1012DF CB	TH1015DF CB	TH1018DF CB	TH1021DF CB	TH1024DFD CB
1218	1198							
		TH1206D CB	TH1208D CB	TH1212DF CB	TH1215DF CB	TH1218DF CB	TH1221DF CB	TH1224DFD CB
1388	1368							
		TH1306D CB	TH1308D CB	TH1312DF CB	TH1315DF CB	TH1318DF CB	TH1321DF CB	TH1324DFD CB
1560	1538							
		TH1506D CB	TH1508D CB	TH1512DF CB	TH1515DF CB	TH1518DF CB	TH1521DF CB	TH1524DFD CB
1820	1798							
		TH1806D CB	TH1808D CB	TH1812DF CB	TH1815DF CB	TH1818DF CB	TH1821DF CB	TH1824DFD CB
2128	2108							
		TH2106D CB	TH2108D CB	TH2112DF CB	TH2115DF CB	TH2118DF CB	TH2121DF CB	TH2124DFD CB

















































NOTE: Double hung windows fitted with spring balances and keylocks standard in beige, black and white.

300 SERIES CEDAR CASEMENT WINDOWS

Stud Opening	630	870	1230	1590	1830	2070	2400	2790
Frame Size	608	848	1178	1568	1808	2048	2378	2768
958	938							
		TC0906	TC0908	TC0912 CF	TC0915 CF	TC0918 CF	TC0921 CF	TC0924 CFC
1049	1028							
		TC1006	TC1008	TC1012 CF	TC1015 CF	TC1018 CF	TC1021 CF	TC1024 CFC
1220	1198							
		TC1206	TC1208	TC1212 CF	TC1215 CF	TC1218 CF	TC1221 CF	TC1224 CFC
1390	1368							
		TC1306	TC1308	TC1312 CF	TC1315 CF	TC1318 CF	TC1321 CF	TC1324 CFC
1580	1538							
		TC1506	TC1508	TC1512 CF	TC1515 CF	TC1518 CF	TC1521 CF	TC1524 CFC
1820	1798							
		TC1806	TC1808	TC1812 CF	TC1815 CF	TC1818 CF	TC1821 CF	TC1824 CFC
2128	2108							
		TC2106	TC2108	TC2112 CF	TC2115 CF	TC2118 CF	TC2121 CF	TC2124 CFC

**All sashes fitted with Truth winders.
Keylocks are not available with Truth Hardware. Min 608 Truth Hardware.**

CEDAR SLIDING WINDOWS

Stud Opening		1230	1590	1830	2070	2400	2790
Frame Size		1208	1568	1808	2048	2378	2768
618	598	 TS0612	 TS0615SF	 TS0618SF	 TS0621SF	 TS0624SF	 TS0627SF
958	938	 TS0912	 TS0915SF	 TS0918SF	 TS0921SF	 TS0924SF	 TS0927FSF
1049	1028	 TS1012	 TS1015SF	 TS1018SF	 TS1021SF	 TS1024SF	 TS1027FSF
1220	1198	 TS1212	 TS1215SF	 TS1218SF	 TS1221SF	 TS1224SF	 TS1227FSF
1390	1368	 TS1312	 TS1315SF	 TS1318SF	 TS1321SF	 TS1324SF	 TS1327FSF
1560	1538	 TS1512	 TS1515SF	 TS1518SF	 TS1521SF	 TS1524SF	 TS1527FSF
1820	1798	 TS1812	 TS1815SF	 TS1818SF	 TS1821SF	 TS1824SF	 TS1827FSF
2128	2108	 TS2112	 TS2115SF	 TS2118SF	 TS2121SF	 TS2124SF	 TS2127FSF

NOTE:

Cedar sliding windows fitted with key locking hardware in silver, beige, black or white as standard.

MINIMUM HEIGHT IS 598MM.

CEDAR FRONT ENTRIES & SIDELIGHTS

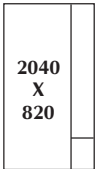
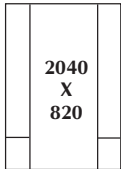
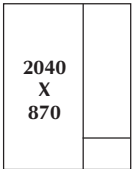
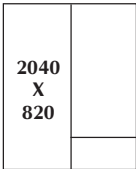
	1230	1440	1520	1770	
2108	 2040 X 820	 2040 X 820	 2040 X 870	 2040 X 820	<ul style="list-style-type: none"> ■ 2108 – With Sill ■ 2077 – No Sill



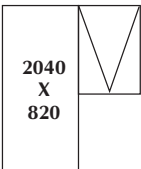
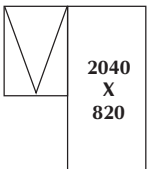







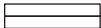

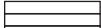
LAUNDRY FRAMES

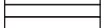

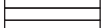

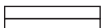

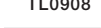

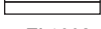





	1458	1458	
2108	 2040 X 820	 2040 X 820	<ul style="list-style-type: none"> ■ 2108 – With Sill ■ 2077 – No Sill

NOTE: Cedar front entries, sidelights & laundry frames have not been tested for water resistance.

■ Standard Rebate in door Frames is 42mm

CEDAR LOUVRES

Stud Opening	630		870		No. of Blades
	Frame Size	608	848		
428	408			2	
		TL0306	TL0308		
568	548			3	
		TL0506	TL0508		
708	688			4	
		TL0606	TL0608		
848	828			5	
		TL0806	TL0808		
988	968			6	
		TL0906	TL0908		
1128	1108			7	
		TL1006	TL1008		
1268	1248			8	

Stud Opening	630		870		No. of Blades
	Frame Size	608	848		
1408	1388			9	
		TL1306	TL1308		
1548	1528			10	
		TL1506	TL1508		
1688	1668			11	
		TL1606	TL1608		
1828	1808			12	
		TL1806	TL1808		
1968	1948			13	
		TL1906	TL1908		
2108	2088			14	
		TL2006	TL2008		
2248	2228			15	

NOTE: Heights of Louvres windows are set to accommodate full size blades 152mm. Sizes do not always match Hanlon standard heights. Matching heights including fixed blade available on request.

RETRACTABLE SCREENING FOR EURODOOR BI-FOLDING

ES2 Specifications

max frame size	
single screen	2400mm (H) x 3000mm (W)
double screen	2400mm (H) x 5800mm (W)

Putting an end to the compromises between uninterrupted views and unrestricted movement and the need to eliminate unpleasant flying pests.

Including a world-first fully integrated insect screening solution for bi-fold scale openings. ES2 screens are ready for action as soon as temperatures allow. The rest of the year the screen system can be rolled back out of view, with hardware integrated into the architecture of the door frame itself.

Created for real life use, ES2 allows for children friendly operation with fingertip ease using a simple magnetic catch which is operable from any height on the stile. Once positioned the screen can be released without fear of slamming shut.

Single Screen

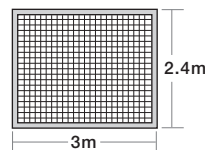



A single screen up to 2.4m high may be up to 3m wide.

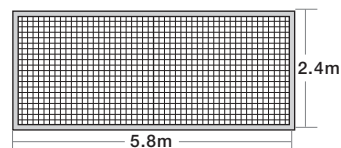

Double Screen



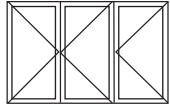
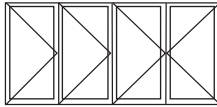
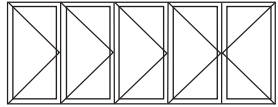
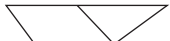

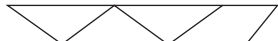
A double screen up to 2.4m high may be up to 5.8m wide.

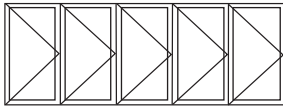
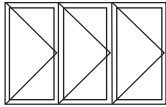
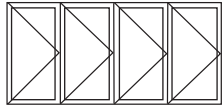
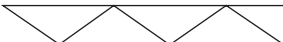
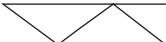
CEDAR EURODOOR BI-FOLDING

Stud Opening		width + 20mm	width + 20mm	width + 20mm																												
Frame Size		Refer to door size	Refer to door size	Refer to door size																												
2164	2144																															
		<p>EU1L/2R</p> <table border="1"> <thead> <tr> <th>DOOR SIZE</th> <th>OVERALL WIDTH</th> </tr> </thead> <tbody> <tr><td>620</td><td>1954mm</td></tr> <tr><td>720</td><td>2254mm</td></tr> <tr><td>770</td><td>2404mm</td></tr> <tr><td>820</td><td>2554mm</td></tr> </tbody> </table>	DOOR SIZE	OVERALL WIDTH	620	1954mm	720	2254mm	770	2404mm	820	2554mm	<p>EU3L/1R</p> <table border="1"> <thead> <tr> <th>DOOR SIZE</th> <th>OVERALL WIDTH</th> </tr> </thead> <tbody> <tr><td>620</td><td>2578mm</td></tr> <tr><td>720</td><td>2978mm</td></tr> <tr><td>770</td><td>3178mm</td></tr> <tr><td>820</td><td>3378mm</td></tr> </tbody> </table>	DOOR SIZE	OVERALL WIDTH	620	2578mm	720	2978mm	770	3178mm	820	3378mm	<p>EU4L/1R</p> <table border="1"> <thead> <tr> <th>DOOR SIZE</th> <th>OVERALL WIDTH</th> </tr> </thead> <tbody> <tr><td>620</td><td>3202mm</td></tr> <tr><td>720</td><td>3702mm</td></tr> <tr><td>770</td><td>3952mm</td></tr> <tr><td>820</td><td>4202mm</td></tr> </tbody> </table>	DOOR SIZE	OVERALL WIDTH	620	3202mm	720	3702mm	770	3952mm
DOOR SIZE	OVERALL WIDTH																															
620	1954mm																															
720	2254mm																															
770	2404mm																															
820	2554mm																															
DOOR SIZE	OVERALL WIDTH																															
620	2578mm																															
720	2978mm																															
770	3178mm																															
820	3378mm																															
DOOR SIZE	OVERALL WIDTH																															
620	3202mm																															
720	3702mm																															
770	3952mm																															
820	4202mm																															
																																

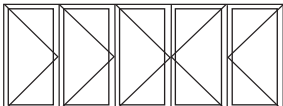
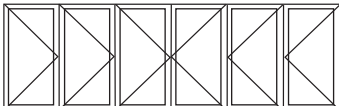
Stud Opening		width + 20mm	width + 20mm	width + 20mm																												
Frame Size		Refer to door size	Refer to door size	Refer to door size																												
2164	2144																															
		<p>EU5L</p> <table border="1"> <thead> <tr> <th>DOOR SIZE</th> <th>OVERALL WIDTH</th> </tr> </thead> <tbody> <tr><td>620</td><td>3202mm</td></tr> <tr><td>720</td><td>3702mm</td></tr> <tr><td>770</td><td>3952mm</td></tr> <tr><td>820</td><td>4202mm</td></tr> </tbody> </table>	DOOR SIZE	OVERALL WIDTH	620	3202mm	720	3702mm	770	3952mm	820	4202mm	<p>EU3L</p> <table border="1"> <thead> <tr> <th>DOOR SIZE</th> <th>OVERALL WIDTH</th> </tr> </thead> <tbody> <tr><td>620</td><td>1954mm</td></tr> <tr><td>720</td><td>2254mm</td></tr> <tr><td>770</td><td>2404mm</td></tr> <tr><td>820</td><td>2554mm</td></tr> </tbody> </table>	DOOR SIZE	OVERALL WIDTH	620	1954mm	720	2254mm	770	2404mm	820	2554mm	<p>EU4L</p> <table border="1"> <thead> <tr> <th>DOOR SIZE</th> <th>OVERALL WIDTH</th> </tr> </thead> <tbody> <tr><td>620</td><td>2578mm</td></tr> <tr><td>720</td><td>2978mm</td></tr> <tr><td>770</td><td>3178mm</td></tr> <tr><td>820</td><td>3378mm</td></tr> </tbody> </table>	DOOR SIZE	OVERALL WIDTH	620	2578mm	720	2978mm	770	3178mm
DOOR SIZE	OVERALL WIDTH																															
620	3202mm																															
720	3702mm																															
770	3952mm																															
820	4202mm																															
DOOR SIZE	OVERALL WIDTH																															
620	1954mm																															
720	2254mm																															
770	2404mm																															
820	2554mm																															
DOOR SIZE	OVERALL WIDTH																															
620	2578mm																															
720	2978mm																															
770	3178mm																															
820	3378mm																															
																																

Stud Opening		width + 20mm	width + 20mm														
Frame Size		Refer to door size	Refer to door size														
2164	2144																
		<p>EU3L/2R</p> <table border="1"> <thead> <tr> <th>DOOR SIZE</th> <th>OVERALL WIDTH</th> </tr> </thead> <tbody> <tr><td>620</td><td>3202mm</td></tr> <tr><td>720</td><td>3702mm</td></tr> <tr><td>770</td><td>3952mm</td></tr> <tr><td>820</td><td>4202mm</td></tr> </tbody> </table>	DOOR SIZE	OVERALL WIDTH	620	3202mm	720	3702mm	770	3952mm	820	4202mm	<p>EU3L/3R</p> <table border="1"> <thead> <tr> <th>DOOR SIZE</th> <th>OVERALL WIDTH</th> </tr> </thead> <tbody> <tr><td>620</td><td>3826mm</td></tr> <tr><td>720</td><td>4426mm</td></tr> </tbody> </table>	DOOR SIZE	OVERALL WIDTH	620	3826mm
DOOR SIZE	OVERALL WIDTH																
620	3202mm																
720	3702mm																
770	3952mm																
820	4202mm																
DOOR SIZE	OVERALL WIDTH																
620	3826mm																
720	4426mm																
																	

NOTE:

Eurodoor hardware available in brass coated or satin chrome. All units over 65kgs will be delivered unglazed and site glazed at customers request.

- Opposite hands available
- Frames over 3600 wide may be joined
- Configurations over 65kgs are site glazed
- 2444 high available

- All doors viewed from the outside
- Open in option available
- Maximum panel width 820mm
- Keyed bottom flush bolt
- Non-keyed at the top
- Hardware to passage door supplied by builder
- Open in doors do not have a water rating

CEDAR HINGED FRENCH DOORS

		880	930	1290	1490	1590	1690	1790
FRAME HEIGHT 2108 with Standard Opening in Sill 2077 with Standard Opening - No Sill	Single Light	GD820 	GD870 	GD620x2 	GD720x2 	GD770x2 	GD820x2 	GD870x2
	Chair Rail							
	6 Light							
	8 Light							
	10 Light							
	Federation							

ALL DOORS SUPPLIED LOOSE — Hardware by Builder

- All timber products have natural variations in colour, texture or grain pattern which are not to be considered defects
- Prior to hanging the door panel, the entire door, including door top and bottom edges, must receive two coats of paint, varnish or sealer to prevent undue absorption of moisture
- Failure to observe these guidelines may void your product warranty
- Doors over 710mm wide have muntin bar and 2 fielded panels
- Cedar hinged french doors have not been tested for water resistance
- No warranty on primed products



CEDAR
Fielded Panel also available to low lights

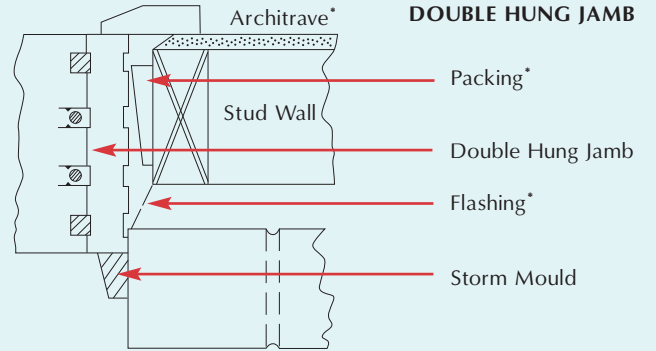
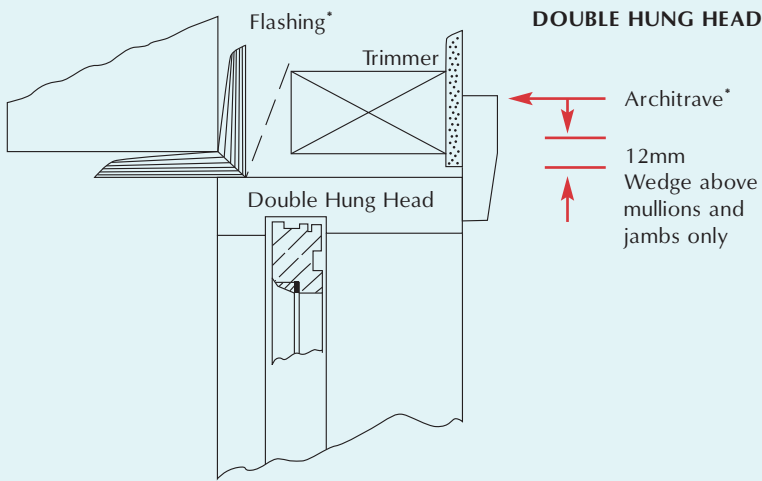
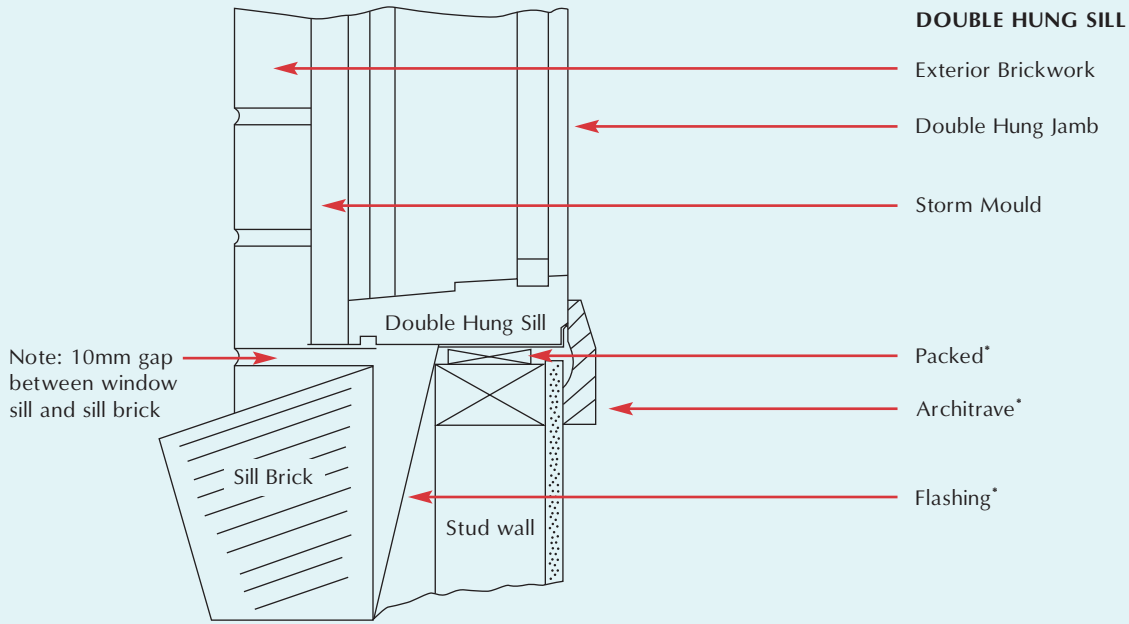

*By Builder

CEDAR BAY WINDOW

SUGGESTED CALCULATIONS DETAILS FOR BAY WINDOWS

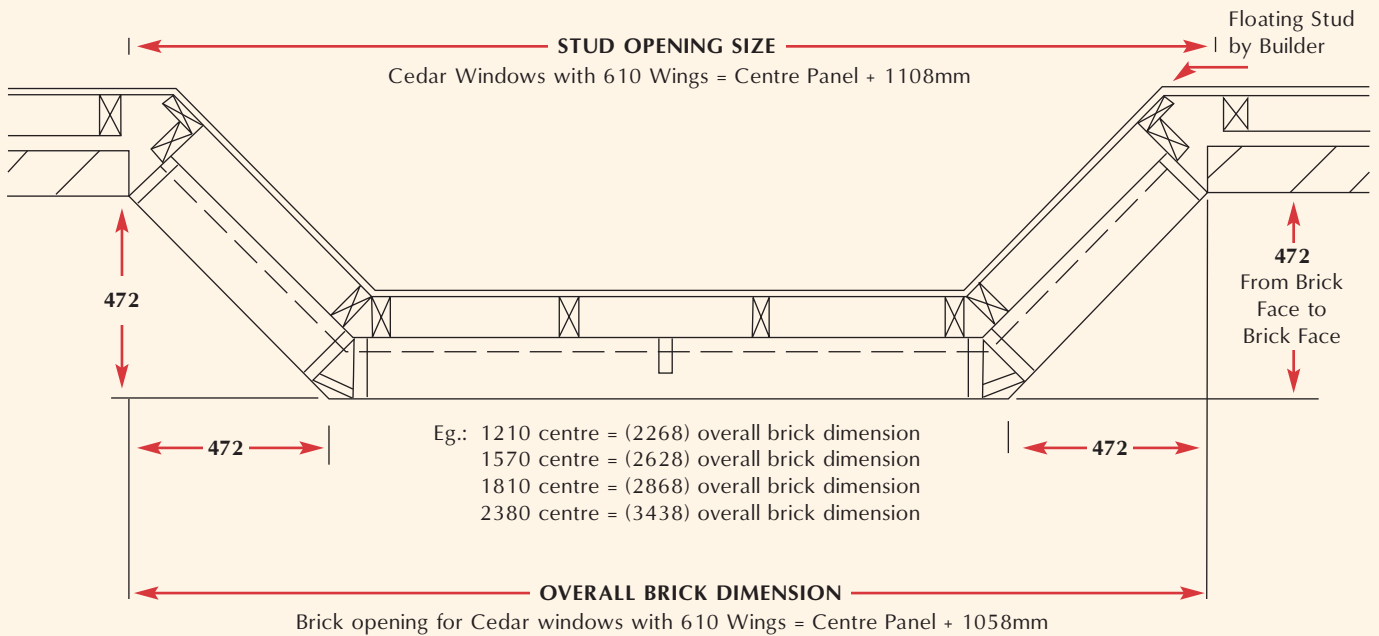

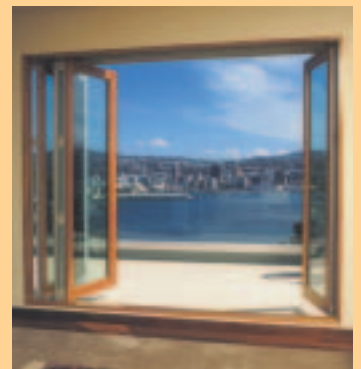

Servicing Sydney, Wollongong,
Southern Highlands, Shoalhaven,
ACT & Far South Coast Areas.



HANLON WINDOWS AUSTRALIA PTY LIMITED

Showroom Locations:

Head Office
41 Bolong Road
Bomaderry NSW 2541
Tel: (02) 4421 5811
Fax: (02) 4421 0739

Unit C, 91-95
Victoria Road
Drummoyne NSW 2047
Tel: (02) 8752 8600
Fax: (02) 8752 8601

104 Industrial Road
Oak Flats NSW 2529
Tel: (02) 4257 1012
Fax: (02) 4257 1238

HIA Home Ideas Centre
28 Collie Street
Fyshwick ACT 2609
Tel: (02) 6239 2233
Fax: (02) 6280 7611

Website: www.hanlonwindows.com.au • Email: sales@hanlonwindows.com.au



A view to the future